

HANDLE PARTS - MODEL SNOWFOX

ELECTRIC SNOW THROWER

PPN 31A-040-800

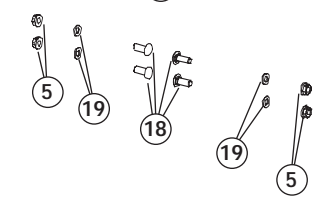
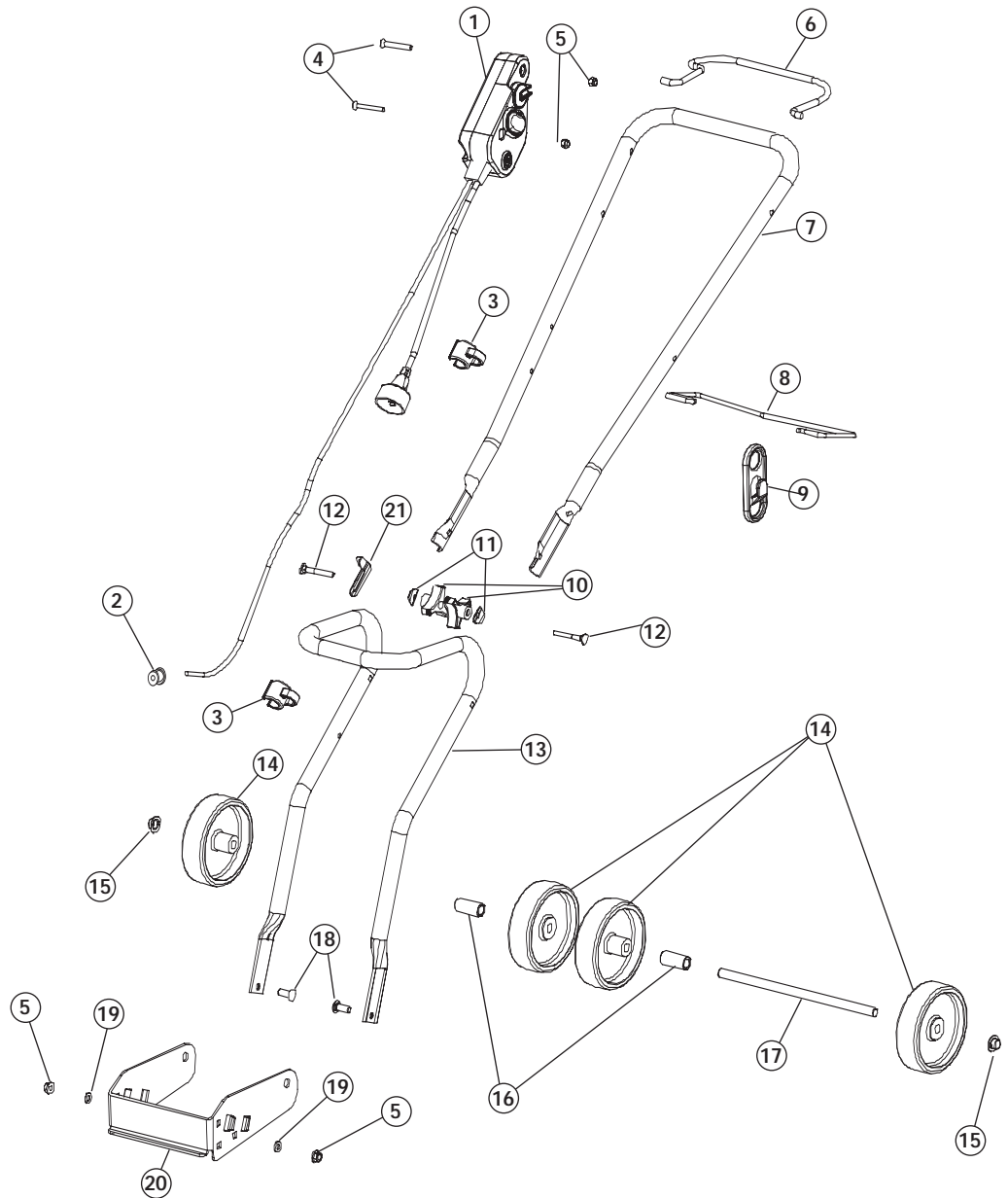

Item	Part No.	Description
1	753-04427	Switch Asm
2	753-04428	Bushing
3	753-04429	Cable guide
4	753-04430	Screw
5	753-04431	Nut
6	753-04432	Bail
7	753-04433	Upper Handle
8	753-04434	Guide Bar
9	753-04435	Cord Restraint
10	791-182677	Knob
11	753-04052	Washer
12	791-182899	Bolt
13	753-04436	Lower Handle
14	753-04437	Wheel
15	753-04062	Push Cap
16	753-04438	Spacer
17	753-04439	Axel
18	791-182213	Bolt
19	791-182678	Washer
20	753-04440	Wheel Bracket
21	753-04441	Control Rod Bracket

MOTOR/TROWER PARTS - MODEL SNOWFOX ELECTRIC SNOW THROWER

PPN 31A-040-800

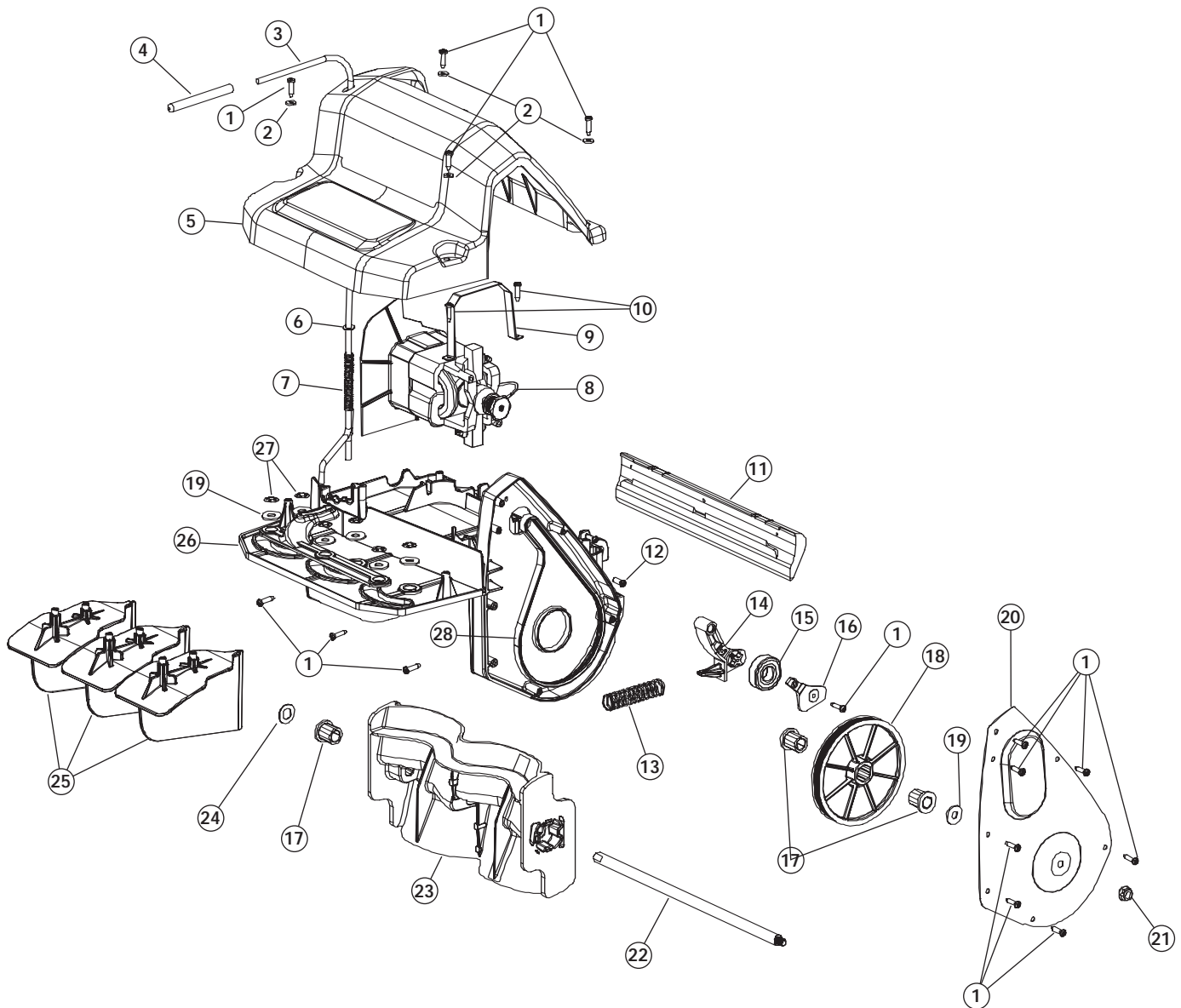

Item	Part No.	Description
1	791-181345	Screw
2	791-182409	Washer
3	791-000012	Vane Control Handle (includes 4)
4	791-000001	Grip
5	753-04416	Cover
6	753-04079	Washer
7	791-000002	Spring
8	753-04421	Motor Assm w/Baffle, Fan & Pulley
9	753-04422	Motor Strap
10	791-181862	Screw
11	791-00010	Scraper
12	791-181858	Screw
13	791-00015	Spring
14	791-00016	Idler Arm
15	753-04081	Ball Bearing
16	791-00017	Keeper
17	753-04082	Flange Bearing

Item	Part No.	Description
18	791-00018	Driven Pulley
19	753-04080	Washer
20	753-04443	Bert Case Cover
21	753-04056	Flange Lock Nut
22	791-00022	Axle Auger
23	753-04423	Auger
24	791-182910	Washer
25	753-04424	Vane
26	753-04425	Snow Thrower Housing
27	791-00013	Push Nut
28	791-00014	Drive Belt